



GEM-P801

Control Panel/Communicator

Installation Instructions

Table of Contents

General Information	2
GEM-P801 Features	2
Specifications	3
UL Compatible Smoke Detectors.....	4
Listings and Approvals	4
Ordering Information	4
Optional Accessories	4
Programming the Panel	5
Installation	6
Wiring	6
Keypad Operation	7
Panel Operation	8
Bypassing	9
User Program Mode.....	10
GEM-P801 Commands	10
Dealer Commands	11
Wireless Operation (Signal Strength)	11
Zone Features.....	12
System Times	13
System Features	14
Telephone Number 1 Programming.....	16
Backup Telephone Programming	17
Pager Programming.....	17
Telephone Number 3 Programming.....	18
Report Codes	19
Enhanced Communicator Features	19
Wireless	19
Downloading	21
Dealer Programming	22
System Troubles	23
Troubleshooting	25
GEM-P801 Wiring Diagram	27
Limited Warranty	28

General Information

The GEMINI GEM-P801 control panel provides up to 6 hardwired/wireless zones, a 2-wire fire zone and 2 wireless only zones. Up to eight 4-digit user codes can be programmed. Ambush, when selected, uses User 8 code as an Ambush code.

The GEM-P801 is wireless ready. When used with a GEM-RECV-XP8 receiver, the control panel can support up to 8 wireless zones, 4 wireless smoke detectors and 4 Keyfobs.

The GEM-RP8 keypad provides complete control of the GEM-P801 control panel. Information on system status, bypassed zones, system troubles etc. can be viewed at the keypad.

The control panel can be easily and quickly programmed from the keypad. The panel can also be locally or remotely downloaded using PCD-Windows Version 4.1 software and a PCI2000/3000 interface or PCL2000B local Download cable. See Downloading Section (pg. 5) for more information.

GEM-P801 Features

Control Panel

- 8 Zones (6 Hardwired/Wireless + 2 wireless)
- 2-wire Fire Zone
- 3 Keypad Panics
- Wireless Ready
- Bell Supervision
- Line Cut Detection
- Answering Machine Override (Second Call)
- 50 Event Log

Communicator

- 2 Telephone Numbers
- Backup Reporting
- Pager Format
- Point ID Format
- Individually Report 8 Users
- Opening after Alarm Report (Cancel Code)
- Conditional Closing Report

NAPCO Security Systems, Inc.
333 Bayview Avenue ● Amityville, New York 11701
For Sales and Repairs, call Toll Free: (800) 645-9445

For Technical Assistance, Contact the NAPCO Toll Free Helpline 
(800) 645-9440

Specifications

Current & Voltage Ratings

Alarm Output ----- Burg: 12 VDC, 2A (max.)
Fire: 12 VDC, 65 mA

Output Current Limiting ----- Burg/Fire: 2.25 A
AUX Power: 750 mA

Residential Burglary (4 Hour Standby)
Combined Standby Current: ----- 500 mA
Bell Output: ----- 2 A
(Using Rechargeable 12 VDC 4 AH BATTERY, minimal requirement)

Residential Fire (4 Hour Standby)
Combined Standby Current: ----- 500 mA
Bell Output: ----- 65 mA
(Using Rechargeable 12 VDC 4 AH BATTERY, minimal requirement)

Residential Fire (24 Hour Standby)
Combined Standby Current: ----- 120 mA
Bell Output: ----- 95 mA
(Using Rechargeable 12 VDC 7 AH BATTERY, minimal requirement)

Transformer and Battery

Required Transformer: ----- NAPCO TRF12 OR
BASLER 16.5 VAC 20VA

Required Battery: ----- 12V 4 AH or 7 AH Rechargeable
Change Battery every 5 years or as required

Maximum Charging Current: ----- 165 mA

Maximum Input Current: ----- 2.58 A

Loop Characteristics

Loop Voltage: ----- 5 Volts

Loop Current : ----- 1.1mA

Loop Resistance: ----- 300Ω per zone (max.)

Device Specifications

Max # keypads: ----- 4, GEM-RP8 current = 65 mA

Max # of receivers: ----- 2, GEM-RECV-XP8
current = 65 mA each

Max # of compatible
2-wire smoke detectors : ----- 10

Max Keypad wire length : ----- 1000' total wire length

Miscellaneous

Housing Dimensions : ----- 11" x 12¹/₈" x 3"
(28 x 30.8 x 7.6) HxWxD

Shipping Weight: ----- GEM-P801 5.5 lbs.

Operating Temperature: ----- 0-49°C (32-120°F)

WI1089 GEM-P801 Installation Instructions

UL Compatible Smoke Detectors

GEM-P801 Compatible Smoke Detectors (Approved by UL)

Mfg	4-Wire Smoke Detector		2-Wire Smoke Detector		Smoke Detector Base
Sentrol	449AT	449CSST	712U	721UT	701U
	449C	449CLT	722U	731U	702U
	449CRT	449CSLT	732U		702RE
	449CST	449CTE	711U		702RU
	449CSRT	741U	721U		
	449CSRH	742U			
System Sensor	1112	2112T	2100	1100	
	2112	2112TSRB	2100T		
NAPCO	FW-4		FW-2		

Listings and Approvals

UL HOUSEHOLD FIRE AND BURGLARY WARNING SYSTEM CONTROL UNIT STANDARDS # 1023, 985

California State Fire Marshal (CSFM) - Control Unit (Household) # 7187-0992:126

VERIFIED TO COMPLY WITH F.C.C. PART 15 AS CLASS B : DIGITAL DEVICE

European E.M.C. Regulations CE Certification

HARMONIZED STANDARDS: EN50081-1 and EN50082-1

EC DIRECTIVES: 89/336/EEC, Electromagnetic Compatibility Directive

Ordering Information

GEM-P801 8 zone Control Panel with 2-wire Fire
(6 Hardwire/Wireless+2 wireless)
GEM-RP8 Keypad
OI219 Operating Instructions GEM-P800 Series
WI1090 Programming Instructions GEM-P801

Optional Accessories

GEM-RECV-XP8: *Wireless Receiver
GEM-TRANS2 Window/Door Transmitter
GEM-KEYF: Keyfob Transmitter
GEM-WP: Wireless Waterproof Panic Button
GEM-SMK: Wireless Smoke Detector
GEM-HEAT: Wireless 135°F / Rate of Rise Heat Detector
GEM-PIR: Wireless PIR
GEM-PIRPET: Wireless Pet-Immune PIR
GEM-DT: Wireless Dual-Technology Sensor
GEM-GB: Wireless Glass-Break Detector
RB1000 Single Form C Relay Board
Veriphone: Audio Verification Module
PCD-Windows: Downloading Software for IBM Compatible PC
Must be PCD-Windows Version 4.1
PCI2000/3000: Downloading Interface for IBM Compatible PC
(includes PCL2000B Local Download cable)
PCL2000B: Local Download cable
*Supports up to 8 zones, 4 Key Fobs, 4 Smoke Detectors
Note: Wireless and Access Features have not been evaluated by UL

Programming the Panel

Refer to GEM-P801 Programming Instructions (W11090)

Defaulting the Panel

1. Remove power from the panel.
2. Remove all wiring from terminal 19 (PGM) and terminal 3.
3. Connect terminal 19 (PGM) to terminal 3.
4. Apply power to the GEM-P801 control panel.
5. After a few seconds the ARMED, READY and SYSTEM TROUBLE LEDs will flash.
6. The keypad will beep 3 times indicating the panel default values have been loaded.
7. Remove wiring between terminal 19 (PGM) and terminal 3.
8. Re-install original wiring for terminal 19 (PGM) and terminal 3.

Note:

Any programming in *Dealer Options 1* [96] and *Dealer Options 2* [97] will not be defaulted. If *Dealer Code Lockout* has been programmed the panel will not default the Dealer Code.

Keypad Programming

Refer to W11090 for information on keypad programming.

Downloading

The GEM-P801 panel can be download/uploaded with PCD-Windows Version 4.1 software using the Ring Method, Answering Machine Override (Second Call) or A 6 method of downloading. The panel can also be automatically downloaded/uploaded using the

PCPreset utility. For Site Initiated Downloaded, see *Auto Download ID Number* [93].

Local Downloading

Wire as shown in Figure 1. Use the power up or A 6 method of establishing a connection. The power up method is recommended if the panel is attempting to report.

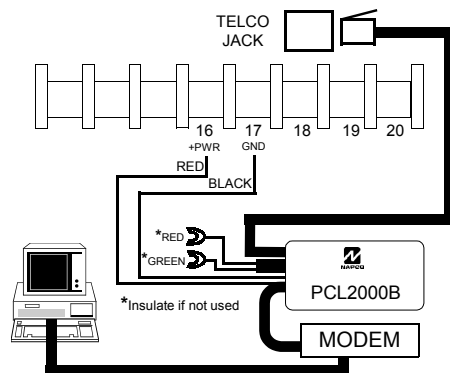

FIGURE 1 LOCAL DOWNLOAD

Remote Downloading

Wire as shown in Figure 2. The panel can be remotely download/uploaded using any one of the following methods:

1. The A 6 method
2. Call-in method
3. Answering Machine Override (Second

Call)

4. Site-Initiated (PCPreset & A 6)
5. Automatic Downloading (Using PCPreset)

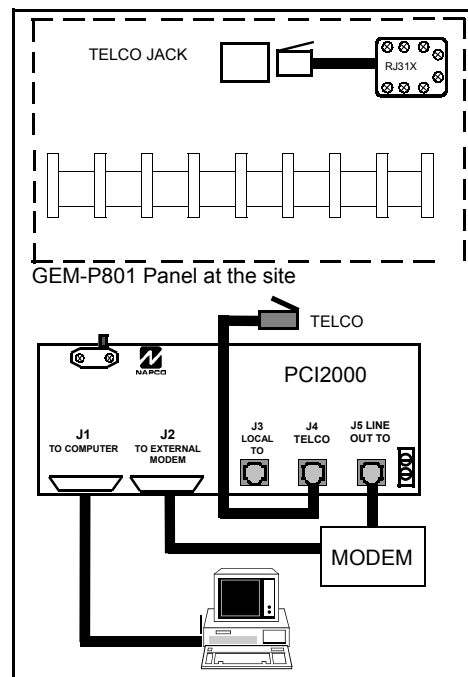

FIGURE 2 REMOTE DOWNLOAD

Installation

Mounting the Panel

Mount the Panel close to an unswitched AC source, a cold-water pipe ground, and a telephone line connection.

Mounting the Keypad

A keypad should be located near an exit/entry door. To remove the keypad from the backplate, insert a small screwdriver into the slots at the bottom of the keypad. Pull up on the screwdriver to pop off the cover.

Up to 4 keypads can be connected on individual wire runs with #22 AWG wire with a maximum total cable length of 1000 feet. Each keypad draws approximately 65 mA.

Keypad Wire Color	Control Panel Terminal
RED	12 (+PWR)
BLACK	13 (GND)
GREEN	14 (GREEN)

TABLE 1 KEYPAD WIRING

Typical Fire Installation

(Where permitted by local codes)

Install smoke detectors outside each sleeping area and on each floor, including the basement. Install the living room and basement smoke detectors near the stairway of the next upper level. For increased protection, additional detectors should be installed in areas other than

those required, such as the dining room, bedrooms and utility room. Heat detectors, rather than smoke detectors, are recommended in kitchens, attics, and garages due to conditions that may result in false alarms and improper operation.

Refer to NFPA Standard 74 (National Fire Protection Association, Batterymarch Park, Quincy, MA 02269) for additional information, including proper mounting methods.

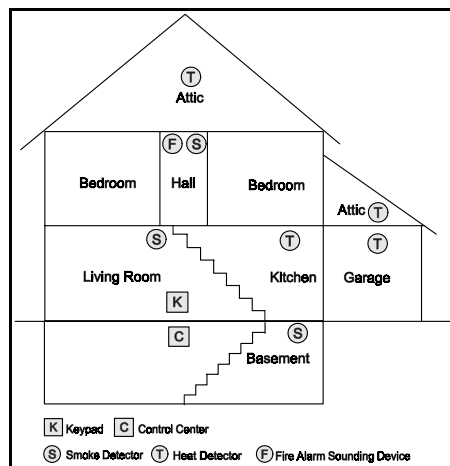

FIGURE 3 Typical Fire Installation

Wiring

Grounding the Panel

Connect the control-panel EARTH GROUND screw through a No. 16 AWG or larger wire to a metal cold-water pipe. Do not use a gas pipe, plastic pipe or AC ground connections. Use at least #16 AWG wire. Connect a wire with a ground lug crimped or soldered onto one end and connect it to the EARTH GROUND screw in the cabinet.

AC Power and Battery Wiring

Complete all wiring before connecting the battery or AC Power. Do not plug the transformer into a switched outlet.

Telephone Wiring

Wire as shown in the wiring diagram in the back of this manual.

WARNING

The FCC restricts the use of this equipment on certain telephone lines. Read the FCC statement on the back of this manual to ensure compliance.

Burglary Zone Wiring

The GEM-P801 provides 6 true hard-wired, End-Of-Line Resistor terminated burglary zones. Wire zones as shown in the wiring diagram (pg. 27). All resistors must be installed, even if the zone is not used. If required, the feature No End Of Line Resistor may be programmed, in which case a direct short across the zone will cause the zone to set up. (NOTE: Not for UL applications) Program the zone as a *No EOL Resistor Zone* [06].

If necessary, use the voltage chart below to verify proper voltages. These values represent the DC voltage of the zone while in the indicated state with reference to the the zone's respective ground terminal.

Zone Normal (EOL across zone)	2.5 V
Zone shorted	0 V
Zone Open	5 V

TABLE 3 VOLTAGE AT TERMINALS 3&5, 6&8, 9&11

Fire Zone Wiring

Wire the Fire Zone as shown in the Wiring Diagram in the back of this manual. An EOL resistor must be installed, even if the Fire Zone is not used.

Fire Zone Normal	13.0V
Fire Trouble	13.8V
Fire	0.0 V

TABLE 4 VOLTAGE AT FIRE ZONE (Terminals 12&13)

PGM Wiring

The PGM (Terminal 19) is a switched negative output that is activated through programming option(s) that have been selected in programming blocks [08], [23] - [25], [26-2]. Connect the device controlled by the PGM between +PWR and the PGM terminal. (maximum load of 50 mA).

Keypad Operation

Keypad zone LEDs indicate zone status. ARMED, STATUS and H SYSTEM LEDs provide system status. The keypad sounder provides feedback beeps for correct and incorrect entries.

Keypad Sounder

3 QUICK BEEPS

Panel Armed (System ON)
Chime ON
Fault Find Mode ON
Keypad Sounder ON
Zone Bypassed

6 QUICK BEEPS

Panel Disarmed (System OFF)
Chime OFF
Fault Find Mode OFF
Keypad Sounder OFF
Zone Un-Bypassed

1 SECOND - STEADY TONE

Incorrect Code Entered
Invalid key entry

4 LONG BEEPS (PRIORITY CONDITION)

1. Entering an Arm Code with a faulted zone (Not an Auto-Bypass Reentry Zone).
2. Entering an Arm Code when the Bell or PGM is ON (Bell and PGM will turn OFF).
3. Arming with the Fire LED ON - reset required. Press the **c** key.

Keypad LEDs

ARMED LED DEFINITION

Armed	ON
Instant Mode	Rapid Flash
Zone in Alarm	Flashing

STATUS LED DEFINITION

Ready to be Armed	ON
Zone faulted	OFF

H TROUBLE LED DEFINITION

AC Failure	Flashing
System Trouble(s)	ON

I FIRE LED DEFINITION

Fire Alarm	Flashing
Fire Memory/*Fire Trbl	ON
*See Note 1	

AC LED DEFINITION

AC Present	ON
AC Failure	OFF

ZONE LED DEFINITION

Faulted Zone	ON
Bypassed Zone	Slow Flash
Zone in Alarm	Flashing

NOTE:

* If *Fire Trouble on Fire LED* [96-4] has been enabled, a steady Fire LED will indicate Fire Trouble.

Panel Operation

Arming (System ON)

Before arming the system close all protected zones (unless programmed as Auto-Bypass Reentry Zones). Enter a 4-digit Arm/Disarm code, followed by the **⏏** key, the keypad will provide a feedback beep for each key pressed. If a valid Arm/Disarm code is entered, the keypad will beep 3 times. If an incorrect Arm/Disarm code is entered, the keypad will sound a 1-second tone indicating an incorrect entry.

Arming without Entry Delay (Instant Mode)

Enter the **F** key to eliminate the entry delay. The ARMED LED will flash rapidly to indicate the panel is in Instant Mode. If an Exit/Entry Zone is tripped while the panel is in Instant Mode the panel will go into alarm immediately.

Arming/Disarming with a Keyfob

The system can be armed by pressing the **[ON]** key, and disarmed by pressing the **[OFF]** key on the Keyfob. Zones programmed as *Exit/Entry Follower Zones* can be bypassed when the **[A1]** or **[A2]** keys on the Keyfob have been programmed for *Interior* [81-84]. Zones programmed as *Home/Away with Delay Zones* can be armed regardless of the state of the *Exit/Entry Zones* when the **[A1]** or **[A2]** keys on the Keyfob have been programmed for *Full Set* [81-84]. To arm the system with all zones

protected press the **[ON]** key. Press and hold the **[A1]** or **[A2]** key for 1.5s to fully set the system (The LED on the Keyfob indicate the Keyfob has transmitted the signal). Program *Keyfob/Keyswitch Chirp* [23-4] for an audible indication of system arming and disarming.

Arming/Disarming with a Keyswitch

The system can be armed/disarmed by using a momentary Keyswitch wired to **Zone 6**. Program *Keyfob/Keyswitch Chirp* [23-4] for an audible indication of system arming and disarming. To convert keyswitch operation from Normally Closed style to Normally Open, program [27-1] Keyswitch Polarity.

NOTE:

Faulted Keyswitch or silent 24 hour zone normally do not display at the keypad. If a silent 24 hour zone or Keyswitch is faulted at the time of arming the faulted zone will display only while the priority sound is ON.

Arming Instant with a Keyfob

The panel can be ARMED INSTANT when the [A1] or [A2] keys on the Keyfob have been programmed for *Instant* [81-84]. To arm the system with Instant protection press the **[ON]** key, then press and hold the [A1] or [A2] key for 1.5s to arm the panel with INSTANT protection.

Disarming (System OFF)

After entering the premises through an Exit/Entry Zone, the keypad will sound the Entry Delay Tone. Enter a valid Arm/Disarm code, then press **[⏏]**. If a valid Arm/Disarm code is entered, the

keypad will beep 6 times, indicating the panel has been disarmed. The red Armed LED will go out. If an incorrect Arm/Disarm Code is entered, the keypad will sound a 1-second tone, indicating incorrect entry. Press the **C** key and re-enter the code.

Disarming after an Alarm (Alarm Memory)

The armed LED and the zone(s) that caused the alarm will be flashing. Disarm the panel. The system is currently not detecting zone faults or displaying system trouble. The zone(s) that caused the alarm will continue to flash. The STATUS and HSYSTEM TRBL LEDs are out indicating:

The system is displaying **Alarm Memory**.

Press the **C** key to clear Alarm Memory.

Bypassing

Automatic Bypassing

Note: Automatic Bypassing has not been evaluated by UL

Home/Away with Delay Zones

This zone type has the following operation depending on whether an *Exit/Entry Zone* has been violated during the *Exit Delay* time.

Home

Exit/Entry Zone is not violated

Zones selected as Home/Away with Delay Zones will be bypassed automatically.

Away with Delay

Exit/Entry Zone is violated

Zones selected as Home/Away with Delay Zones will have a fixed 20-second entry delay when violated before an *Exit/Entry Zone*.

Full Setting the System with Automatic Bypassing - Home/Away with Delay Zones

From the Keypad

Press **B C** to return protection to *Home/Away with Delay Zones* that have been automatically bypassed. Three minutes are allowed to walk through *Exit/Entry* and *Exit/Entry Follower Zones*.

Using A Keyfob (GEM-KF)

All zones in the system can be armed regardless of the state of the *Exit/Entry Zone* when arming with a Keyfob and using an AUX key programmed as **Full Set**. Press [ON] and press and hold the [A1] or [A2] keys for 1.5s when leaving the premises. All zones, including *Home/Away Zones* are armed.

Bypassing a zone

Press the **B** key, then the zone number to be bypassed. While the panel is DISARMED, the bypassed zone LED will flash slowly; indicating the zone has been bypassed. While the panel is ARMED, the bypassed zones will only be displayed if the *Display Bypassed* [21-3] option has been selected.

Unbypassing a zone (Disarmed only)

Press the **B** key then the number of the zone to be unbypassed.

Group Bypass

Press the **E** key to Bypass all *Exit/Entry Follower Zones* [02] or *Home/Away Zones* [01] (only if the system is programmed exclusively for *Home/Away with Delay zones*).

Using A Keyfob (GEM-KF)

Hold the [A1] or [A2] key on the Keyfob to Bypass all *Exit/Entry Follower Zones* [02] or *Home/Away Zones* [01] (only if the system is programmed exclusively for *Home/Away with Delay zones*).

User Program Mode

To prevent the loss of the User 1 Code, the panel default program includes *User 1 Code Lockout* [96-2].

To change the User 1 Code from its default value of **1234**, program the 4-digit User 1 Code through Dealer Programming [95]. User 1 Arm/Disarm code is also used to program User Codes 2 - 8. By default, the User 1 code cannot be re-programmed by the user.

If it is necessary to change the User 1 code, it can be changed through downloading or Dealer keypad programming. From Dealer Program Mode, change the *User 1 Code Lockout* ([96-2] LED=OFF) to disabled.

Entering User Program Mode

WI1089 GEM-P801 Installation Instructions

1. Enter **A** **8**
2. Enter User 1 Code (**1** **2** **3** **4**)
(Default)
3. Press **⏏**

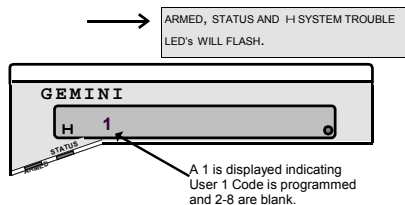

Zone LED	Meaning
OFF	User Arm/Disarm Code not programmed
Flashing	User Arm/Code is currently being programmed
Steady	User Arm/Disarm Code has been programmed

TABLE 5 ZONE LED DEFINITION-USER PROGRAM MODE

While in User Program Mode the Armed, Status and H-System Trouble LEDs will continue to flash, follow the example below to program **User 2's** code to **1923**.

User Mode Programming Example:

1. Press **2** , Zone 2 LED will Flash
2. Enter **1** **9** **2** **3** , Zone 2 LED will continue to flash until the 4th digit is entered. The keypad will beep 4 times confirming a valid entry (Zone LED steady).

Deleting a User Code

Press the number of the User to be deleted, the zone LED will be flashing indicating that the user has been selected. Press the **F** key, the LED associated with the user will now be OFF.

Exiting User Program Mode

To exit User Program Mode press the **C** key.

GEM-P801 Commands

User Commands

A 1 Bell Test

Enter this command to turn on the Bell, keypad sounder and keypad LEDs for 2 seconds. The battery is tested during a Bell Test, and automatically every *24 hours to ensure proper battery operation under load. The Alarm output requires a battery in order to supply the specified output. If the battery cannot sustain

the load, a low battery indication will be displayed. A battery test is also performed on power-up after a 3 minute delay.

*A battery test occurs every 4 hours when *Household Fire* [96-3] has been selected.

D Easy Arm

Press this key to arm the panel. To disarm the panel a valid Arm/Disarm code must be entered. Requires *Easy Exit/Easy Arm* [21-2] to be enabled.

E Interior

Enter this command to bypass all *Exit/Entry Follower Zones* or *Home/Away Zones* (only if the system is programmed exclusively for *Home/Away with Delay Zones*).

F Instant

Enter this command before or after arming to remove the entry delay on *Entry/Exit Zones*. The keypad ARMED LED will flicker rapidly. Faulting a *Exit/Entry Zone* will result in an immediate alarm.

A 5 Chime ON/OFF

Enter this command to turn chime ON/OFF. The Keypad will chime on any zone that has not been selected as an *Exit/Entry Follower Zone*, *Home/Away with Delay Zones*, or *24 Hour Zone*.

A 8 + User 1 Code - User Program Mode

A 9 Keypad Sleep Mode ON/OFF

Enter this command to turn the keypad sounder ON/OFF. When the keypad is in Sleep mode all keypad sounds will be silenced except for keypad feedback beeps and Keypad Sounder on Alarm.

User Commands - Optional

A 0 Easy Exit

If enabled in Dealer programming, enter this command while the panel is Armed to allow 3 minutes to exit the premises through *Exit/Entry* and *Exit/Entry Follower Zones*.

A 3 Access on PGM

If enabled in Dealer programming, enter this command to activate the PGM output (Terminal 15) for 5 seconds.

Dealer Commands

A 6 Download (Programming Required)

Establish a connection between the PCD-Windows phone line and the Control Panel phone line. When ready, tell the installer to arm, then disarm. Then enter A 6 in order to establish a connection. Phone connection to installer will go "dead" as downloader and panel connect.

A 7 Fault Find ON/OFF

Hardwired Zone Operation

Enter this command to turn Fault Find ON/OFF.

While in Fault Find mode, the loop response for all zones will be set to the faster response of 40 ms. The keypad will beep for .25-seconds when hardwired zones are faulted and for 1-second when zones are restored.

Wireless Operation (Signal Strength)

While in Fault Find mode the keypad will provide an audible (Table 6) and visual (Figure 5) indication of each transmitter's signal strength. The signal strength metering is based on a scale of 4 to 10, with 4 being marginal and 10 being excellent.

The keypad will beep out a number, from 1-4, corresponding to the signal strength of the transmitter. See Table 6. Each beep is 1-second long. The keypad will sound a short beep for transmitters with signal strengths of 3 or less.

SIGNAL STRENGTH	KEYPAD SOUNDER
3 or less	.25s BEEP
4	BEEP
5	BEEP BEEP
6-7	BEEP BEEP BEEP
8-10	BEEP BEEP BEEP BEEP

TABLE 6 AUDIBLE SIGNAL STRENGTH INDICATION

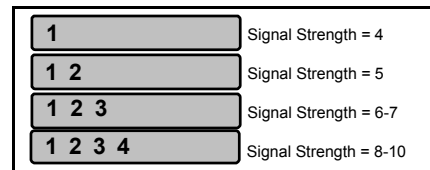

FIGURE 5 VISUAL SIGNAL STRENGTH INDICATION

Signal Strength Logging Mode

The Signal Strength Logging Mode is a troubleshooting tool which allows the collection of signal strength information for all transmitters on the system. Normally the Signal Strength of Supervisory Signals are not logged; during Signal Strength Logging Mode the signal strength information for all supervisory signals received over a two hour period will be saved to the LOG.

Local Activation

Enable [92-4=ON], this will initiate a two hour test period where all supervisory signals will log signal strength information.

Remote Activation

Using PCD-Windows V4.1 Software, follow the instructions below:

From the Status Screen:

Select [Enable Signal Strength Logging]

The Signal Strength logging mode will automatically time out in 2 hours.

Uploading Signal Strength Information from the Log

After approximately (2) two hours, re-establish a connection with the panel. Signal strength log information ranges from 1 to 10. The logging of signal strength should appear similar to the sample LOG below:

```
07/24/97 17:44 QL: Full Program Uploaded
07/24/97 17:42 QL: Technical Connection
              (callback) Technician 2
07/24/97 15:23 Transmitter Status: GEM_SMK
              1(7A0DB5): SS=7
07/24/97 15:13 Transmitter Status: GEM_SMK
              2(768447): SS=8
07/24/97 15:13 Transmitter Status: Zone 2,
              SS=6
07/24/97 14:27 Trouble: RF Link,
              GEM_RECV 1
07/24/97 14:25 Panic: Keypad
07/24/97 14:25 Panic: Keyfob 1(933780)
              SS=8
07/24/97 14:25 Dealer Program Mode Entered
07/24/97 14:24 Instant: Keyfob 1(933780)
              SS=8
07/24/97 14:24 QL: Connection Terminated
              (10 MIN T/O)
07/24/97 13:13 QL: Full Program Downloaded
```

Zone Features

[00]Exit/Entry Zones

Delay allows exit and entry through an Exit/Entry Zone after the system is armed without setting off an immediate alarm. *Exit Delay* allows the user to leave the premises after arming. *Entry Delay* allows the user time to enter and disarm. The entry delay may be canceled by pressing F .

[01]Home/Away with Delay Zones

Zones that automatically bypass at the expiration of the exit delay if the EXIT/ENTRY zone(s) are not violated. Zones of this type have a three (3) minute power-up delay, and do not display or cause an alarm if faulted when the system powers up. Pressing the C key cancels the 3 minute timer.

If Exit/Entry zone(s) are violated during the exit delay, zones programmed as Home/Away with Delay Zone(s) will have a fixed 20-second entry delay, if violated before the Exit/Entry zone.

To eliminate this fixed 20-second entry delay, also program zones as *Exit/Entry Follower Zones* [02].

To return protection to zones of this type, press BC from the keypad or [A1] or [A2] from a Keyfob. Program the Keyfob AUX 1 or AUX 2 button for **Full Set** [81-7].

NOTE:

If A O is Entered during *Exit Time*, *Home/Away with Delay Zones* will be automatically bypassed, even if the *Exit/Entry Zone* is violated. *Easy Exit/Easy Arm* [22-2] must be enabled.

[02]Exit/Entry Follower Zones

Entry Delay allows the user time to enter and disarm. Allows exit after the panel is armed without setting off an immediate alarm and allows entry only if an *Exit/Entry Zone* [00] has been violated first. Zones of

this type have a three (3) minute power-up delay, and do not display or cause an alarm if faulted when the system powers up. Pressing the C key cancels the 3 minute timer.

Group Bypassing - Zones programmed as *Exit/Entry Follower Zones* will be Group bypassed if the E key is pressed while disarmed or within the *Exit Delay*.

Auto Interior Bypassing - Also program zones as *Home/Away with Delay Zone(s)* [01] to automatically bypass at the expiration of the exit delay if the *EXIT/ENTRY Zone(s)* are not violated during the exit delay.

[03]Auto-Bypass Reentry Zones

Zones programmed as this zone type are permitted to be faulted at the time of arming. Once the zone is restored, while the control panel is still armed, the zone will automatically be unbypassed and any subsequent violations of the zone will cause an alarm condition.

[04]24-Hour Protection

A zone that provides protection at all times, whether or not the system is armed.

[05]40 ms Loop Response

Normally loop response is 750 ms, select this option to change the loop response to 40 ms. The slower the loop response, the less sensitive the system will be to intermittents (swingers). The programming option is not

permitted for UL installations.

[06]Disable EOL Resistor

Program this zone type if an End Of Line Resistor is not required on the zone(s). If programmed, a direct short across the zone will cause the zone to set up normally.

This programming option is not permitted for UL installations.

[07]Burg (Steady) Output

Enables the Bell Output on a zone trip for each zone selected. The Bell Output will remain ON for the length of time programmed for *Burg (Steady) Output* [07] or it will remain ON until turned off by entering a valid Arm/Disarm Code; 0 means output will stay ON until reset.

[08]PGM Output

Enables the PGM Output on a zone trip for each zone selected. The PGM Output will remain ON until reset.

[09]Selective Bypass

If programmed, selected zones will be able to be bypassed by the User. By default, all zones are permitted to be bypassed.

System Times

[10]Exit Delay

The delay time which permits exit through an *Exit/Entry Zone* [00] after the system is

armed, allows a user to leave the premises without setting off an immediate alarm. *Exit Delay* may be programmed for up to 255 seconds (4¼ minutes); a value of 0 defaults to 60 seconds.

[11]Entry Delay

Delay time permits entry through *Exit/Entry Zone(s)* after the system is armed without setting off an immediate alarm. *Entry Delay* allows the user time to enter and disarm the system. Upon entering, the keypad sounder will sound a steady tone (Entry Sound) to remind the user to disarm the system. *Entry Delay Time* [11] may be programmed for up to 255 seconds (4¼ minutes); a value of 0 defaults to 30 seconds. *Entry Delay* may be canceled by pressing **F** before or after arming.

[12]Burg (Steady) Output Time-out

Can be programmed from 1 to 255 min (4¼ hours); 0 means output will stay ON until turned off by entering an Arm/Disarm Code.

[13]Fire (Pulsed/Temporal) Output T/O

Can be programmed from 1 to 255 min (4¼ hours); 0 for output active until silenced by entering an Arm/Disarm Code. For temporal sounder, enable [96-3] UL Household Fire.

[14]Test Timer Interval

Test Timer

If Test Timer [36-4] is enabled, program the interval, in days, between Test Timer reports. Valid entries are from 1 to 255 days.

[15]Line Cut Time-to-Fail

Enable this feature by programming the delay time required to declare a line cut failure. Programming 000 will disable line cut detection.

[16]Wireless Supervisory Timer

A transmitter will send a transmission every time it is tripped; when there is no activity, the transmitter sends a supervisory transmission about once an hour. If the receiver does not receive any signal (either a trip or a status) from a transmitter in the time specified, a system trouble 'RF Supervisory Failure' will be indicated at the keypad. Timer is programmable from 1-26 hours; 0 means NO supervision.

[17]Wireless Smoke Supervisory Timer

A smoke detector will send a transmission every time it is tripped; when there is NO activity, the smoke detector sends a supervisory transmission about once an hour. If the receiver does not receive a signal (either a trip or a status) from a transmitter in the time specified, a system trouble 'RF Supervisory Failure' will be

indicated at the keypad. The Supervisory timer is programmable from 1-8 hours; 0 means NO supervision. Note: If UL Household Fire is enabled, the Wireless Smoke Supervisory Timer will automatically be set to 4 hours.

[18]Test Timer Offset

Enter the time, in hours, that a Test Timer will be reported after Dealer Mode has been exited. With the default value of 12, the test timer will be sent 12 hours after exiting Dealer Mode. The test timer can also be offset using PCD-Windows Downloading Software. On power up the test timer is sent immediately. Follow the commands below to offset the test timer using Quickloader Software:

- 1 From the Status Screen, select **Miscellaneous**
- 2 Enter the number of hours for Test Timer Offset
- 3 Select Set Test Timer Offset
- 4 Select OK

System Features

[20]Keypad Features 1

(1) Enable Keypad Fire (8 6)

Additional Programming required:
Select reporting to Telco 1 [36-1] or Telco 3 [56-1].

(2) Enable Keypad AUX (8 6)

Additional Programming required:
Select reporting to Telco 1 [36-2] or Telco 3 [56-2].

(3) Enable Keypad Panic (9 6)

Additional Programming required:
Select reporting to Telco 1 [36-3] or Telco 3 [56-3].

(4) **Enable Ambush** - If enabled, the 8th User Code will send an Ambush report when entered to disarm the system.

Additional Programming required:
Program User 8 Arm/Disarm Code.
Select reporting to Telco 1 [36-2] or Telco 3 [56-2].

UL Installations: If Keypad Fire [20-1] is enabled, the keypad must be mounted within (3) three feet from the Control Panel.

[21]Keypad Features 2

(1) **Audible Panic** - Keypad Panic will not turn the Bell on unless this option is programmed.

(2) **Exit/Entry with Urgency** - select to give an audible indication of Exit and Entry times. During the last 10 seconds of entry and exit time, the keypad sounds a distinct sound to indicate the premises must be left or the panel must be disarmed.

(3) **Display Bypassed (Armed)** - Select to display bypassed zones while the panel is armed.

(4) **Disable Code Entry Beeps** - Program to disable keypad beeping on valid code

and function entries.

[22]Miscellaneous Features 1

(1) **Abort Delay** - Program to allow a 15 second Delay (except *24 Hour Zones*) after a zone trip before reporting. Disarm the system within 15 seconds to prevent reporting.

(2) **Easy Exit/Easy Arm-** Enables A O command. While the system is armed, entering this command allows 3 minutes to Exit through *Exit/Entry* and *Exit/Entry Follower Zones*. Enabling this option also enables Easy Arm, press the D key to arm the system.

(3) **Swinger Shutdown** - Automatically disables armed zones with excessive alarm/restores (swingers). Non-24-Hour Protection zones: allows only 3 alarms and 2 restores per zone per arming before the zone is disabled.

(4) **Bell on Line Cut (Armed)** - Program to turn the Bell Output on if the telephone line has been cut while the panel is armed.

[23]Programmable Output Features 1

(1) **Audio Verification** - Program to activate the PGM during reporting. Select specific zones for audio verification by programming the required zones in *PGM Output* [08], *PGM Features 2* [24] and *PGM Features 3* [25]. Connect the PGM to the Veriphone™ trigger low input.

(2) **Access Output** - Activates the PGM

output for 5 seconds using the Δ 3 command. This programming option has not been evaluated by UL.

(3) Follow Keypad Sounder - The following keypad sounds will activate the PGM output: Entry Sounder, Keypad Pulsing Sounder, Keypad Output on Alarm, Chime, Fault Find.

(4) Keyfob/Keyswitch Chirp - Program to chirp the Bell Output when the system is armed or disarm by a GEM-KEYF KeyFob or by keyswitch. It will chirp the bell output (1) one time when the panel is armed or (2) two times when the panel is disarmed.

[24]Programmable Output Features 2

- (1) Fire** - Program to activate the PGM on a Fire alarm.
- (2) AUX** - Program to activate the PGM on a AUX alarm.
- (3) Panic** - Program to activate the PGM on a Panic alarm.
- (4) Test Timer** - Program to activate the PGM during a Test Timer report.

[25]Programmable Output Features 3

- (1) AC Fail** - Program to activate the PGM on the loss of AC. (15 minute delay)
- (2) Low Battery** - Program to activate the PGM on a Low Battery condition.
- (3) *Trouble** - Program to activate the PGM on a Trouble condition.
- (4) Armed** - Program to activate the PGM

when the panel is Armed. The PGM output will flash when the panel has gone into alarm.

*Includes Bell Cut, Fire Trouble, Receiver Fail-to-Respond, Receiver Tamper, Receiver JAM, Wireless Smoke Low Battery, Wireless Smoke Supervisory Fail.

[26]Miscellaneous Features 2

(1) Momentary Keyswitch Arming - For Keyswitch Arm/Disarm, connect a normally-open momentary Keyswitch across Zone 6 zone AND its 2.2K EOLR.

(2) Reserved

(3) Inhibit Fail-to-Communicate Display - This option prevents the keypad from either indicating or sounding when a Fail to Communicate has occurred.

(4) Inhibit Low Battery Display - Program to inhibit the Low Battery Display at the keypad. Low Battery Reporting is not inhibited. The programming option is not permitted for UL installations.

[27]Keyswitch Polarity

(1) Keyswitch Polarity - program to convert keyswitch operation from Normally Closed style to Normally Open.

[29]Programmable Chime Time

(1) Chime Time - Program chime in 1/4 second increments. For 1 second, program 4, for 2 seconds, program 8, etc.. Valid entries are 2 - 9. 0 defaults to 1 second.

Telephone 1 Programming

[30]Subscriber ID Number

For 4/2 format enter a 4 digit number. If 3/1 format is required, enter a 3 digit number, then press the F key to blank the last digit.

[31]Telephone Number 1

Program the phone number to be dialed for Telephone Number 1. Program the number directly, just as it is entered on a TouchTone phone. A fixed Dial Tone Detection (E) is included prior to the *Dialing Prefix* (Block Number 44). Programming an E is not required for Telco 1, Telco 2 and Telco 3. If dial tone detection is not desired select *No Dial Tone Detection* in Communicator Features [46-1]. Use the F key to blank out remaining digits in the phone number.

[32]Receiver Format

Select the receiver format to be used to report for Telephone Number 1: Program a 0 to disable reporting to Telco 1.

- | | |
|------------------------|--------------------------|
| [0] Disabled | [4] Universal High Speed |
| [1] Ademco Slow | [5] Reserved |
| [2] Radionics Slow | [6] Point ID |
| [3] Silent Knight Fast | [7] Pager |

[33]Receiver Options

- (1) 2300 Hz HS/Kissoff** - Select 2300 Hz Handshake and Kissoff.
- (2) Sumcheck** - Only used for the following

Receiver Formats: Ademco Slow, Radionics Fast, Silent Knight Fast and Universal High Speed. This is a sophisticated data format used to enhance the speed and check the accuracy of the received transmission. This format should be used whenever the central station has this capability. Instead of sending a second round to verify correct data, the panel sends a Sumcheck digit after sending the Subscriber ID and Alarm Code.

(3) Single Digit - 3/1 Format. 3-digit Subscriber ID number and a 1-digit Alarm Code will be transmitted.

(4) No Handshake - (All receiver formats except Pager Format)
If programmed no Handshake/Kissoff is required by the panel.

[34]Zone Report, Telco 1

Select zone(s) required to send an alarm report to Telephone Number 1.

[35]Zone Restore Report, Telco 1

Select zone(s) required to send a restore report to Telephone Number 1. The zones will send a restore after Bell time-out, unless programmed as silent zones.

[36]System Reporting, Telco 1

(1) Keypad Fire - Program to activate a Keypad Fire report (7 G).

(2) AUX/AMBUSH - Program to activate an

AUX or AMBUSH report (8 G).

(3) Panic - Program to activate a Panic report (9 G).

(4) Test Timer - Program to activate a Test Timer report.

[37]System Reporting, Telco 1

(1) AC Fail Report - Program to activate an AC Fail report (15 minute fixed report delay).

(2) Low Battery Report - Program to activate a Low Battery report.

(3) *Trouble Report - Program to activate a Trouble report.

(4) Fire Report - Program to activate a Fire report.

*Includes Bell Cut, Fire Trouble, Receiver Fail-to-Respond, Receiver Tamper, Receiver JAM, Wireless Smoke Low Battery, Wireless Smoke Supervisory Fail. Point ID format will report trouble(s) by device and ID number.

[38]System Restore Report, Telco 1

(1) AC Restore - Program to activate an AC Restore report.

(2) Battery Restore - Program to activate a Battery Restore report.

(3) Trouble Restore - Program to activate a Trouble Restore report.

(4) Fire Restore - Program to activate a

Fire Restore report.

[39]Opening/Closing Report, Telco 1

Select users required to send opening and closing reports to Telephone Number 1. Do not program for users that are intended to send an *Opening After Alarm* (Cancel Code) or *Conditional Closing* reports.

Backup Telephone Programming

[40]Subscriber ID Number (Telco 2)

For 4/2 format enter a 4 digit number. If 3/1 format is required enter a 3 digit number then press the F key.

[41]Telephone Number 2

Program the phone number to be dialed for Telephone Number 2. A fixed dial tone detection (E) is included prior to the Dialing Prefix [44]. Dial tone detection can be disabled by programming *No Dial Tone Detection* [46-1]. To program any additional delay enter a "D" where required in the phone number.

[42]Receiver Format (Telco 2)

Select the format that will be used to report for Telco 2 (Backup reporting). Refer to section [32].

[43]Receiver Options (Telco 2)

Refer to section [33] Receiver Options.

[44]Dialing Prefix

Dialing prefix for Telco 1, Telco 2, and Telco 3. Program if using an Outside access number.

[45]Communicator Features 1

(1) **Communicator Enabled** - Program to enable the communicator.

(2) **DTMF with Rotary Backup** - The first attempt to communicate is dialed using the TouchTone method of dialing, subsequent attempts are dialed using the pulse method of dialing. Disable this feature to dial using only rotary dialing.

(3) **DTMF only** - All attempts to communicate dial using the TouchTone method of dialing.

(4) **Backup Reporting to Telco 2** - After 2 attempts are made to communicate to Telco 1 the backup phone number is dialed (Telco 2).

[46]Communicator Features 2

(1) **No Dial Tone Detection** - Program to disable dial tone detection for Telco 1, Telco 2 and Telco 3.

(2) **2:1 Rotary Dialing** - Changes the make break ratio when rotary dialing from 1.5:1 to 2:1.

(3) **Backup if < 4 attempts** - If *Backup Reporting* [45-4] has been enabled, the communicator will use *Telephone Number 2* [41] for the remaining retries when there are

less than 4 retries remaining.

(4) Don't Clear Fail to Communicate

Program to prevent a good line cut test from clearing a Failure to Communicate system trouble. If programmed, only a successful communication to Central Station will clear a Failure to Communicate system trouble.

Pager Programming

If Pager Format ([32]and/or[42]and/or[52] = 7) is selected, pager data will be displayed as shown in Figure 8. If Pager Format is selected 4/2 format must be programmed and Sumcheck is not permitted. If a PIN number is required refer to Leading Digits [47].

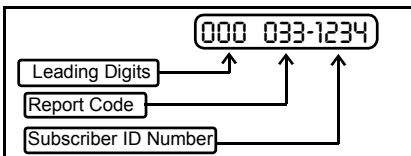

FIGURE 8 DEFAULT PAGER DISPLAY

Pager Alarm data is the same as 4/2 format with the exception that the 2 digit Report Code is transmitted before the 4 digit Subscriber ID.

NOTE:

Digits in Report Codes and subscriber IDs that are programmed with "B" through "F" will be converted to "0"s.

[47]Leading Digits

Pager PIN Number - If a PIN number is required by the paging system, program the PIN number in the Leading Digits location.

See sample program below.

If a 7-digit PIN number is required, program the panel as follows:

[31]/[41]/[51] - Pager Telephone number

[32]/[42]/[52] - Select Pager Format

[47] - **X X X X X X X C**

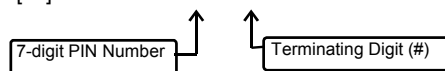

Leading and Trailing digits can be letters B, C or D. B = the * button on a telephone, C = the # button on a telephone, D = 2 second delay.

[48]Trailing Digits

Transmitted after alarm data. Refer to section [47] for programming information.

[49]Pager Options

(1) **Skip Alarm Data** - Once pager format is selected, program this option to skip alarm data. If this option is selected, all the programmed Leading and Trailing digits are sent, but the event code and subscriber ID are not transmitted. With this option selected, a telephone number programmed in Leading Digits or Trailing Digits would send the telephone number to the pager

each time a report is sent.

(2) **Reserved**

(3) **Reserved**

(4) **Reserved**

Telephone 3 Programming

[50] - [59]

Programming is the same as for Telco 1. Program to split/double report to Telco 3. Refer to sections [30] through [39].

Report Codes

[60]Zone Report Codes

Report Code for Zones 1 through 8.

4/2 format - The Zone Report Code is the 1st digit of the report code sent, the second digit is the zone number of the reporting zone. For example, if zone 2 has a report code of 3, the report code would be **32**.

3/1 format - Sends only the report Code and does not append it with the zone number.

[61]Point ID Report Codes

Point ID Report Codes are defaulted to Burglary for zones 1 through 8. Optionally, Point ID codes for zones 1 through 8 can be programmed as follows:

[1] Fire	[7] Gas Alarm
[2] Panic	[8] Heat Alarm
[3] Burglary	[9] Reserved
[4] Holdup	[A] Auxiliary
[5] General Alarm	[B] 24 Hour
[6] Reserved	

[62]Zone Codes

[62-1] Restore code - Zones 1 through 8. The second digit of the restore code is the zone number of the restored zone. For example, if the Zone Restore Code [62] is programmed to **E**, the restore code for that zone would be **E4** (4/2 format).

[62-2] Trouble Code - Conditional Closing Reports. Zones that are bypassed at the time of arming send this code along with the zone number of the bypassed zone(s). For example a conditional closing by User 2, with zones 2 and 3 bypassed would be as follows:

1234 **C2**
F2
F3

[63]System Report Codes

Program a 2-digit report code for *Keypad Fire, Keypad AUX, Keypad Panic, Test Timer, AC Fail, Low Battery, Trouble and Fire*.

[64]System Restore Code

The code sent when a system condition restores. The second digit of the 2-digit restore code is the second digit of the System Report Code [63]. For example, if a Low Battery System Report Code is F8 the Battery Restore would be E8 (4/2 format).

[65]Opening and Closing Codes

Program Opening and Closing Codes for Users 1 through 8. The second digit of the report code is the number of the user that armed or disarmed the system. For example, if the Closing Code [65] is programmed with a **C**, the closing code for User 2 would be **C2** (4/2 format).

[66]Ambush Report Code

Program a 2-digit report code for Ambush. To send an ambush report, program a User Code for User 8, Program report User 8 as Ambush [20-4] and Select reporting for Telco 1 [36-2] and/or Telco 3 [56-2].

Enhanced Communicator Features

[67]Telephone Number 1

(1) Opening After Alarm (Cancel Code) - When enabled, all users that are not selected to report on *Opening/Closing* [39] will report an Opening only when opening after an alarm has occurred.

(2) Conditional Closing Telephone 1 - When enabled, all users that are not selected to report an Opening/Closing ([39], [59]) will report a Closing only when zones have been bypassed. The Zone Trouble Code [62-2] is used to report zones that have been bypassed at the time of the closing report.

- (3) Reserved
- (4) Reserved

[68] Telephone Number 3

- (1) Opening after Alarm (Cancel Code) - see [67-1].
- (2) Conditional Closing Telco 3 - see [67-1].
- (3) Reserved
- (4) Reserved

Wireless

Up to two receivers can be wired to the GEM-P801. Each wireless transmitter can be mapped to a zone. Only 1 wireless device is permitted per zone, however, the use of both hardwired and wireless on a zone is permitted.

To Map a transmitter to a zone:

1. Enter the Programming Block Number that the transmitter is to be mapped to.
2. Enter the 7-digit RF ID number directly, just as it is shown on the device label. After the 7th digit is entered the keypad will beep.

A transmitter will send a transmission every time it is tripped. The transmitter also sends a supervisory transmission about once every hour. If the receiver does not receive a signal from a transmitter in the time

programmed in Wireless Supervisory Timer, a system trouble 'RF Supervisory Failure' will be indicated at the keypad. Program Wireless Supervisory Timer [16] to change the supervisory time from the default of 12 hours.

The Signal strength of a transmitter can be checked at the keypad (see A 7 Fault Find Mode) or saved to the LOG (see Signal Strength Logging Mode - pg. 11).

[71-78] Wireless Transmitters

Enter the RF ID# and the point number that is to be mapped to the zone.

Programming Example

Map point 1 of a window door transmitter with an RF ID# of 0012B0:0 to Zone 3.

1. Enter Dealer Mode.
2. Enter **C** (beeps) **7** **3** (beeps)
3. Enter **1** **2** **G** **2** **0** **0**
Enter **1** (beeps)

Note: If the RF ID# in step 3 is not entered correctly the keypad will emit a 1 second tone indicating incorrect entry. Repeat steps 2 - 4 above.

[81] - [84] Wireless Keyfobs

The GEM-KF is a hand held wireless transmitter capable of Arming and Disarming the control panel and/or

activating 2 Auxiliary Functions. To activate the auxiliary functions, press and hold the [A1] or [A2] key for 1.5 seconds (see WI752 for more information).

Enter the RF ID# and AUX 1 and AUX 2 options for each Keyfob.

AUX 1 & AUX 2 Programming Options:

1 Panic

Program a 1 in the AUX 1 and/or AUX 2 option to initiate a panic alarm when the [A1] or [A2] buttons on the Keyfob are pressed.

Additional programming required:

Keypad Panic (**9P** *****) [20-3]

Panic Report to Telco 1[36-2] and/or Telco 3 [56-3].

Audible Panic (Optional) [21-1]

2 AUX

Program a 2 in the AUX 1 and/or AUX 2 option to initiate a AUX alarm when the [A1] or [A2] buttons on the Keyfob are pressed.

Additional programming required:

Keypad AUX (**8** **G**) [20-2]

AUX Report to Telco 1[36-2] and/or Telco 3 [56-2].

3 Bell ON

Program a 3 in the AUX 1 and/or AUX 2 option to turn the Bell ON when the [A1] or [A2] buttons on the Keyfob are pressed.

Press the [OFF] button to turn the Bell OFF.

4 PGM

Program a 4 in the AUX 1 and/or AUX 2 option to activate the PGM Output when the [A1] or [A2] buttons on the Keyfob are pressed. Press the [OFF] button to turn the PGM Output OFF.

5 Instant

Program a 5 in the AUX 1 and/or AUX 2 option to activate Instant Mode when the [A1] or [A2] buttons on the Keyfob are pressed.

6 Access on PGM

Program a 6 in the AUX 1 and/or AUX 2 option to activate the PGM Output for 5 seconds when the [A1] or [A2] buttons on the Keyfob are pressed.

Addition programming required:
Enable *Access Output* [23-2]

7 Full Set System

Program a 7 in the AUX 1 and/or AUX 2 option to Fully Set the System when the [ON] and the [A1] or [A2] buttons on the Keyfob are pressed, or when the [A1] or [A2] buttons are pressed when the system is armed with *Exit/Entry Follower Zones* or *Home/Away with Delay Zones* that have been bypassed.

Program an 8 in the AUX 1 and/or AUX 2 option to *Bypass Exit/Entry Follower Zones* or *Home/Away with Delay Zones* when the



buttons on the Keyfob are pressed (only if the system is programmed exclusively for *Home/Away with Delay Zones*).

[85] - [88] Wireless Smoke Detectors

Enter the RF ID# of the smoke detector.

A wireless smoke detector sends a supervisory transmission about once every hour. If the receiver does not receive a signal from a transmitter in the time programmed in *Wireless Smoke Supervisory Timer*, a system trouble 'RF Smoke Supervisory Failure' will be indicated on the keypad.

Program *Wireless Smoke Supervisory Timer* [17] to change the time from the default time of 8 hours. Refer to *Household Fire* [96-3].

Note: Mark Smoke Detectors (Smoke 1 through Smoke 4) in order to identify them in the event of a supervisory or battery failure. If *Household Fire* [96-4] is selected, *Wireless Smoke Supervisory Time* is fixed at 4 hours.

Downloading

[90]Callback Telephone Number

Program the phone number of the downloading computer to be dialed by the panel during a high security download.

[91]Ring Count

Program the number of rings before the panel will pickup. *Ring Method* [92-1] (*Downloading Features*) must also be selected.

[92]Downloading Features

(1) Ring Method - Enable the ring method of downloading. The panel will pick-up on the number of rings programmed in *Ring Count* [91].

(2) Answering Machine Override - Using the downloading computer, call the panel. When the operator has determined that the panel has received 1-2 rings, pressing the  key will cause the downloading computer to immediately re-dial the panel. The panel will pick-up on the first ring.

(3) Function 6 Download - Select to enable the  method of downloading (pg. 8).

(4) Signal Strength Test Mode - Program to initiate a 2 hour test period. The signal strength information for all supervisory signals received over a two hour period will be saved to the LOG.

[93]Auto Download ID Number

Enter the Number that is used by PCPreset when downloading using *Site Initiated Auto Downloading* ().

The requirements for Site Initiated Auto Download are as follows:

1. Download Computer running PCPreset.
2. Program the telephone number of the Download Computer in location [90] *Callback Telephone Number*.
3. Program location [93] with the number of the PCPreset account that is to be downloaded.

PCPreset

1. Create the GEM-P801 account to be downloaded using PCD-Windows Quickloader Software.
1. Create a List using PCPreset.
2. Select the account by pressing **[F5]**. Select the desired account from the list of PCD3000 accounts available. (The location in the list is the *Auto Download ID Number* [93])
3. Tag the list by entering **[ALT] [D]** (download)
4. Enter Standby Mode by entering **[F4]**.

The Computer is now in STANDBY Site

At the site perform the following three steps:

1. Arm the panel.
2. Disarm the panel.
3. Enter **A 6**. The panel will now call the download computer running PCPreset. PCPreset will answer the call, establish a connection, and then download the account that matches the

Auto Download ID Number [93] with the account of the same number in the list that PCPreset is currently running.

Dealer Programming

[94]Dealer Code

The default Dealer Code is **4567**. Program a new 4-digit Dealer Code. When the panel is defaulted the Dealer Code will be changed back to the default Dealer Code of **4567** only if Dealer Code Lockout [96-1] has not been programmed.

[95]User 1 Code

The 1st User code is a program code as well as an Arm/Disarm code. The default User Code is **1234**. If User 1 Code Lockout is programmed the User 1 Code cannot be programmed from User Program Mode.

[96]Dealer Options 1

(1) Dealer Code Lockout - Program to prevent the Dealer Code from changing with a panel default.

(2) User 1 Code Lockout - If programmed the User 1 Code cannot be programmed from User Program Mode.

(3) Household Fire - Activates the following UL required features:

There is a 4 hour re-sound of wireless Smoke Low Battery and wireless Smoke Supervisory system troubles.

- An active System Battery test performed every 4 hours instead of 24 hours and Wireless Smoke Supervisory Timer is set to 4 hours.
- Fire Bell Timing is March Time.
- Wireless Smoke Supervisory Time is fixed at 4 hours.

(4) Fire Trouble on Fire LED - Normally all troubles are displayed on the **H**SYSTEM TROUBLE LED, including Fire Trouble. If required Fire Trouble can be displayed on the Fire LED. Fire Trouble is indicated by a steady **I** Fire LED.

[97]Dealer Options 2

(1) International Dialing Protocol - No dialing if no dial tone, 60 s between attempts and 4 s wait for dial tone.

(2) Invert Bell Output - Inverts the Bell polarity and removes supervision from the bell circuit.

(3) System Trouble Auto Restore - Normally, System troubles require acknowledgment (View System Trouble) in order to restore. If this option is selected troubles will restore without requiring acknowledgment.

(4) User 1 Code-Program only - If enabled User 1 Code will function only as the User Program Code and will not Arm/Disarm the panel.

WI1089 GEM-P801 Installation Instructions

Note: All programming within Programming Blocks [96] & [97] will not change if the panel is defaulted.

[98] Number of Re-Dials

The Number of re-dial attempts made by the panel before indicating a *Fail-to-Communicate* (System Trouble 1-3).

System Troubles

Use the System Trouble chart on the following page to determine the specific System Trouble(s).

During normal panel operation the H SYSTEM TROUBLE LED has the following two modes of operation:

STEADY	1-7 possible trouble groups, AC is present
FLASHING	1-7 possible trouble groups, AC is <u>not</u> present

Viewing System Trouble(s)

Press the A 4 key on the keypad.

To determine the System Trouble Group Number, count the number of times the H SYSTEM TROUBLE LED blinks. The keypad sounder will beep at the same rate that the H SYSTEM TROUBLE LED blinks.

To determine the System Trouble, note the zone LED that is ON. Look up the specific system trouble on the chart on the following page.

The H SYSTEM TROUBLE LED and keypad sounder will continue to flash and beep. To view the next System Trouble, if any, press the E key. Continue pressing the E key, if there are no more system troubles to view, the system will return to normal operation.

EXAMPLE - LOW BATTERY SYSTEM TROUBLE DISPLAY

Enter A 4 to enter System Trouble mode and determine the specific trouble. Press any key to view all system troubles.

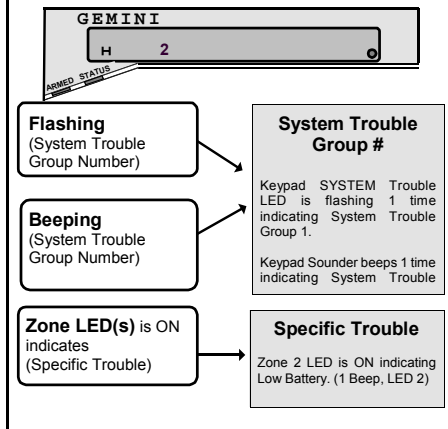

FIGURE 9 SYSTEM TROUBLE EXAMPLE

Note: System Troubles Groups 3 through 7 - System Trouble Groups that have a zone or smoke detector associated with the trouble, such as RF low battery. The zone(s) of the device with a low battery will be displayed by the ZONE LED. For example, a wireless low battery on zone 2 would beep the keypad sounder 3 times and turn on zone 2 LED.

Audible System Trouble Indication - For all system troubles, except when the only system trouble is the loss of AC, the keypad will beep once every 10 seconds. The keypad will continue to beep until the reset button is pressed or the trouble has been acknowledged by pressing the C key.

System Trouble Reporting

The following system troubles, when enabled to report to Telco 1 [37-3] or Telco 3 [57-3], will send the report code programmed in Trouble Report [63] if reporting using a pulse format:

System Trouble	Pulse Report Code
Bell Cut	F1
2-Wire Fire Trouble	F1
Rcvr Fail-to-Respond	F1
Receiver Tamper	F1
Receiver JAM	F1
Tx Low Battery	F1
Tx Supervisory Failure	F1
Smoke Low Battery	F1
Smoke Sup. Failure	F1

If reporting using Point ID, a unique code will be sent for each of the following System Troubles.

System Trouble	Point ID Report Codes
Bell Cut	CODE 1 321 G00 ZN000-BELL 1 TROUBLE
2-Wire Fire Trouble	CODE 1 373 G00 ZN000-FIRE LOOP TRBLE
Rcvr Fail-to-Respond	CODE 1 382 G00 ZN000-SENSOR TROUBLE
Receiver Tamper	CODE 1 145 G00 ZN000-EXP. MODL. TAMPER
Receiver JAM	CODE 1 333 G00 ZN000-FIRE LOOP TRBLE
Tx Low Battery	CODE 1 384 G00 ZN00n-RF TRAN LOW BATT
Tx Supervisory Failure	CODE 1 381 G00 ZN00n-SUPERVSN LOSS RF

A 300 (SYSTEM TROUBLE RST) code is sent if a restore is reported after multiple troubles.

WI1089 GEM-P801 Installation Instructions

System Troubles

Keypad Beeps or J SYSTEM Flashes	Zone LED ON	System Trouble Condition	Cause/Action
1 <i>Beep</i>	1	AC Power Failure	This trouble will occur if AC power is not present. Ensure that the transformer is connected to an unswitched power source.
	2	Low Battery	If there has been a recent power failure, the battery may be partially depleted and must be recharged by the control panel. If the trouble does not go away in 24 hours, replace the battery.
	3	Communication Failure / PCPreset Fail / Line Fail	The system was not able to report to central station. Check panel programming and telephone line wiring. The trouble will clear after it has been acknowledged by viewing the system trouble as long as the telephone line has passed a line cut test (tested automatically by the panel). The Panel did not successfully connect and download/upload with the computer running PCPreset - check Auto Download ID number, Callback Number or PCPreset Setup.
	4	Telephone Line Cut	The telephone line has failed. If telephone service has been temporarily interrupted, the trouble will clear when restored and acknowledged by viewing the system trouble.
2 <i>Beeps</i>	1	Bell/Siren line Cut	There is a problem with the Bell or Siren wiring. EOL2.2K resistor must be installed.
	2	2-wire Fire Trouble	There is a problem with the wiring of the Fire Zone.
	3	Rcvr Fail-to-Respond/Rcvr Tamper	The receiver is not responding to the panel. The red LED on the receiver should be flashing, refer to WI850. The cover is off the receiver causing a tamper signal to be transmitted.
	4	Receiver Jam	A signal is blocking the normal reception of transmissions from the wireless devices. Ensure that the green LED on the receiver is not on continuously, refer to receiver manual WI850.
3 <i>Beeps</i>	1-6	Wireless Transmitter Low Battery	The battery in the wireless transmitter is low and should be replaced. This transmitter is on the zone corresponding to the number of the zone light flashing. The replacement battery for the GEM Trans2 door/window transmitter and the GEM PIR wireless motion detector is the Duracell DL123A. (2 required for the GEM-PIR) WARNING: Replace batteries only with the same type as specified above. Use of another battery may present a risk of fire or explosion. Do not recharge or disassemble battery or dispose of in fire.
4 <i>Beeps</i>	1-6	Wireless Transmitter Supervisory Failure	The panel has not received a supervisory signal from the transmitter within the time programmed. Check <i>Wireless Supervisory Timer</i> [16] Programming. Check the placement of the transmitter and receiver, refer to WI850.
5 <i>Beeps</i>	1-4	Wireless Smoke Detector Low Battery	The battery in the wireless smoke detector is low and should be replaced. This wireless smoke detector should be marked with a number corresponding to the number of the zone light flashing. The replacement batteries required are *Duracell 9 Volt Alkaline (2).
6 <i>Beeps</i>	1-4	Wireless Smoke Detector Supervisory	The panel has not received a supervisory signal from the wireless smoke detector within the programmed time. Check <i>Wireless Smoke Supervisory Timer</i> [17] Programming. Check the placement of the wireless smoke detector and receiver, refer to WI850.
7 <i>Beeps</i>	1-6	Zone Trouble	The panel has one or more of the following 2 possible troubles: Transmitter Tamper or Dual Tech Self Test Fail.

Troubleshooting

1. The bell output drops to about 3 volts in alarm.

The battery/bell circuit is protected by a PC board trace which may have burned open by reversal of the battery leads. It is on the back of the PC board just adjacent to the red & black battery leads. Send in for service if this occurs.

2. How do I remove the Keypad Sounder on Alarm?

The keypad sounder follows the Burg Output. If you need to remove the Keypad Sounder, then you must remove the Burg Output from that zone.

3. How do I activate Chime by Zone?

The Chime feature will automatically be assigned to all zones, except for the following:

1. Zones programmed as Home/Away with Delay.

Zones programmed as Exit/Entry Followers

2. Zones programmed for 24 Hour Protection. To Activate/Deactivate the chime mode, Press A 5 .

4. When using a piezo on the Bell Output, it constantly buzzes.

This is due to the fact that there is a constant loop current flowing through the Bell circuit for supervision. To eliminate this, cut resistor **R26** which is located directly above Terminal 9 just below the heat sink.

5. Where are the fuses?

The control panel incorporates advanced circuitry which automatically limits the current when an over current condition exists without the use of traditional fuses. The circuit will restore automatically when the over current condition is corrected.

6. The PGM Output Pulses in Alarm.

When the PGM lug of the control panel is programmed for an Armed indication it also incorporates an Alarm Memory function which will indicate that the system is in an Alarm condition.

7. I short out the bell and the system does not indicate Bell Trouble.

The Bell Supervision circuit is only designed to detect a "Bell Cut", it does not supervise for a short on the Bell.

8. How do I remove Keypad Sounder on Alarm?

The keypad sounder follows the Burg Output. If you need to remove the Keypad Sounder, then you must remove the Burg Output from that zone.

9. Transmitters not responding?

Open Transmitter case - Keypad should go into X-Mitter Tamper Trouble. If not:

Check Receiver Red LED should be flashing once approx. once a second.

Check Receiver wiring.

Check Programming of Transmitter ID.

If Keypad does go into X-Mitter Tamper Trouble, check:

Transmitter point is programmed correctly.

Transmitter is wired correctly:

If using external switch, make sure it is wired to point 1, and point 2 is jumped out.

If using internal reed, make sure J1 is cut and both Point 1 and Point 2 terminals are jumped out.

10. Keypad LEDs Flicker.

The Keypad is not receiving a POLL from the Panel.

Check Keypad wiring.

1. The Panel is in the process of being Uploaded/Downloaded.
2. The panel is powering up. LED's will flicker until panel has reset and is polling the keypad.
3. The connection from the control panel to the keypad is open.

11. No Keypad Entry Sounder during Entry Time?

The keypad sounder is turned off with the `A 9` command. This command will silence all Keypad sounds except keypad sounder on alarm. Enter `A 9` to turn keypad sounds back on.

12. No Keypad Chime?

The keypad sounder is turned off with the `A 9` command. This command will silence all Keypad sounds except keypad sounder on alarm. Enter `A 9` to turn keypad sounds back on.

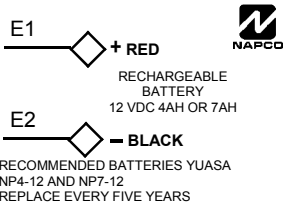

GEM-P801 WIRING DIAGRAM

(REFER TO INSTALLATION INSTRUCTIONS WI1089)

RESIDENTIAL BURG (4 HOUR STANDBY)
COMBINED STANDBY = 500 mA BELL = 2.0 A

RESIDENTIAL FIRE (24 HOUR STANDBY) ⁽²⁾
COMBINED STANDBY = 120 mA BELL = 95 mA

COLD WATER GROUND CONNECTION
USE ONLY COLD-WATER PIPE OR
BURIED GROUND ROD. USE AT LEAST
#16 AWG WIRE.

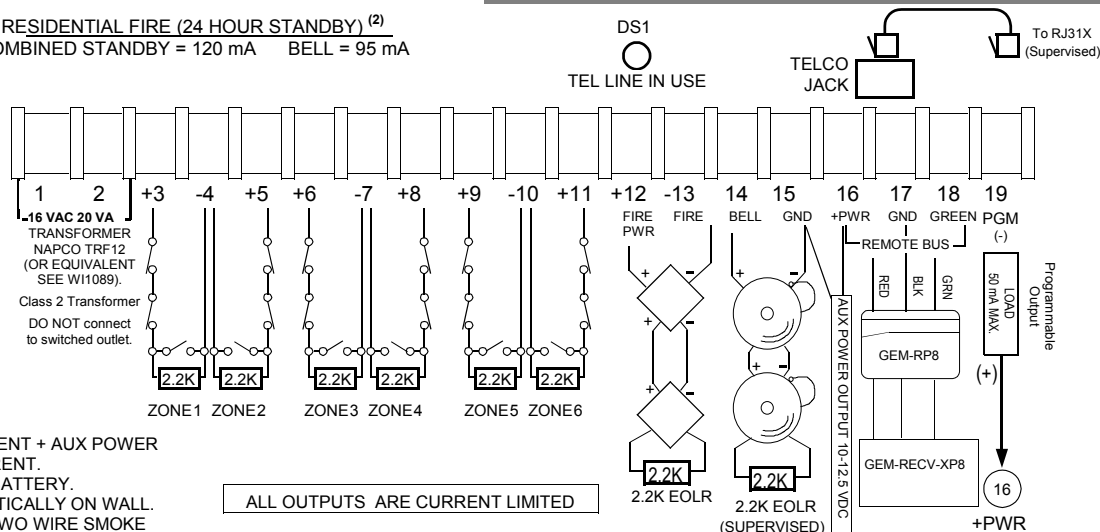

- COMBINED STANDBY = KEYPAD CURRENT + AUX POWER CURRENT + FIRE POWER + PGM CURRENT.
- RESIDENTIAL FIRE REQUIRES A 7AH BATTERY.
- UNIT INTENDED TO BE MOUNTED VERTICALLY ON WALL.
- REFER TO WI1089 FOR COMPATIBLE TWO WIRE SMOKE DETECTORS. DO NOT MIX DIFFERENT MODELS.
- THIS PANEL SHALL BE CHECKED BY A QUALIFIED TECHNICIAN AT LEAST ONCE EVERY THREE YEARS.
- THIS PANEL SUPPORTS ONLY ONE SMOKE DETECTOR IN ALARM.
- USE ONLY ONE BELL IN RESIDENTIAL FIRE APPLICATION.
- SYSTEM MUST BE TESTED AT LEAST ONCE A WEEK IN THE AC/BATTERY MODE AND IN THE BATTERY-ONLY MODE. (CONTACT CENTRAL STATION PRIOR TO TESTING) AC MUST BE RESTORED AFTER TEST.

ALL OUTPUTS ARE CURRENT LIMITED

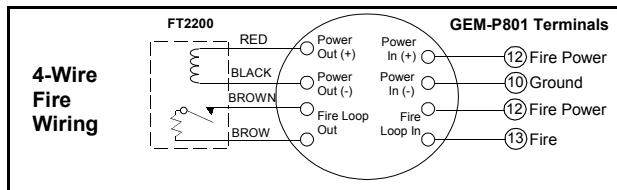

WARNING
TO PREVENT RISK
OF ELECTRIC SHOCK
DISCONNECT TELEPHONE
LINES PRIOR TO

This equipment should be installed in accordance with Chapter 2 of the National Fire Alarm Code, ANSI/NFPA 72-1996 (National Fire Protection Association Battery March Park, Quincy MA 02269), and local codes. Information describing proper installation, operation, testing, maintenance, evacuation planning, and repair service is to be provided with this equipment. UL Listed Energy Cable is required.

NAPCO LIMITED WARRANTY

NAPCO SECURITY SYSTEMS, INC. (NAPCO) warrants its products to be free from any other warranty or liability concerning its products. In no event shall NAPCO be liable manufacturing defects in materials and workmanship for thirty-six months following the date of manufacture. NAPCO will, within said period, at its option, repair or replace any product failing to operate correctly without charge to the original purchaser or user.

This warranty shall not apply to any equipment, or any part thereof, which has been repaired by others, improperly installed, improperly used, abused, altered, damaged, subjected to acts of God, or on which any serial numbers have been altered, defaced or removed. Seller will not be responsible for any dismantling or reinstallation charges.

THERE ARE NO WARRANTIES, EXPRESS OR IMPLIED, WHICH EXTEND BEYOND THE DESCRIPTION ON THE FACE HEREOF. THERE IS NO EXPRESS OR IMPLIED WARRANTY OF MERCHANTABILITY OR A WARRANTY OF FITNESS FOR A PARTICULAR PURPOSE. ADDITIONALLY, THIS WARRANTY IS IN LIEU OF ALL OTHER OBLIGATIONS OR LIABILITIES ON THE PART OF NAPCO.

Any action for breach of warranty, including but not limited to any implied warranty of merchantability, must be brought within the six months following the end of the warranty period. IN NO CASE SHALL NAPCO BE LIABLE TO ANYONE FOR ANY CONSEQUENTIAL OR INCIDENTAL DAMAGES FOR BREACH OF THIS OR ANY OTHER WARRANTY, EXPRESS OR IMPLIED, EVEN IF THE LOSS OR DAMAGE IS CAUSED BY THE SELLER'S OWN NEGLIGENCE OR FAULT.

In case of defect, contact the security professional who installed and maintains your security system. In order to exercise the warranty, the product must be returned by the security professional, shipping costs prepaid and insured to NAPCO. After repair or replacement, NAPCO assumes the cost of returning products under warranty. NAPCO shall have no obligation under this warranty, or otherwise, if the product has been repaired by others, improperly installed, improperly used, abused, altered, damaged, subjected to accident, nuisance, flood, fire or acts of God, or on which any serial numbers have been altered, defaced or removed. NAPCO will not be responsible for any dismantling, reassembly or reinstallation charges. This warranty contains the entire warranty. It is the sole warranty and any prior agreements or representations, whether oral or written, are either merged herein or are expressly canceled. NAPCO neither assumes, nor authorizes any other person purporting to act on its behalf to modify, to change, or to assume for it,

damage, whether direct, indirect, incidental, consequential, or otherwise arising out of any failure of the product. Seller's warranty, as hereinabove set forth, shall not be enlarged, diminished or affected by and no obligation or liability shall arise or grow out of Seller's rendering of technical advice or service in connection with Buyer's order of the goods furnished hereunder.

NAPCO RECOMMENDS THAT THE ENTIRE SYSTEM BE COMPLETELY TESTED WEEKLY.

Warning: Despite frequent testing, and due to, but not limited to, any or all of the following: criminal tampering, electrical or communications disruption, it is possible for the system to fail to perform as expected. NAPCO does not represent that the product/system may not be compromised or circumvented; or that the product or system will prevent any personal injury or property loss by burglary, robbery, fire or otherwise; nor that the product or system will in all cases provide adequate warning or protection. A properly installed and maintained alarm may only reduce risk of burglary, robbery, fire or otherwise but it is not insurance or a guarantee that these events will not occur. CONSEQUENTLY, SELLER SHALL HAVE NO LIABILITY FOR ANY PERSONAL INJURY, PROPERTY DAMAGE, OR OTHER LOSS BASED ON A CLAIM THE PRODUCT FAILED TO GIVE WARNING.

Therefore, the installer should in turn advise the consumer to take any and all precautions for his or her safety including, but not limited to, fleeing the premises and calling police or fire department, in order to mitigate the possibilities of harm and/or damage. NAPCO is not an insurer of either the property or safety of the user's family or employees, and limits its liability for any loss or damage including incidental or consequential damages to NAPCO's original selling price of the product regardless of the cause of such loss or damage.

Some states do not allow limitations on how long an implied warranty lasts or do not allow the exclusion or limitation of incidental or consequential damages, or differentiate in their treatment of limitations of liability for ordinary or gross negligence, so the above limitations or exclusions may not apply to you. This Warranty gives you specific legal rights and you may also have other rights which vary from state to state.

THE FOLLOWING STATEMENT IS REQUIRED BY THE FCC.

This equipment generates and uses radio-frequency energy and, if not installed and used properly, that is, in strict accordance with the manufacturer's instructions, may cause interference to radio and television reception. It has been type tested and found to comply with the limits for a Class-B computing device in accordance with the specifications in Subpart J of Part 15 of FCC Rules, which are designed to provide reasonable protection against such interference in a residential installation.

However, there is no guarantee that interference will not occur in a particular installation. If this equipment does cause interference to radio or television reception, which can be determined by turning the equipment off and on, the user is encouraged to try to correct the interference by one or more of the following measures: reorient the receiving antenna; relocate the computer with respect to the receiver; move the computer away from the receiver; plug the computer into a different outlet so that computer and receiver are on different branch circuits. If necessary, the user should consult the dealer or an experienced radio/television technician for additional suggestions. The user may find the following booklet prepared by the Federal Communications Commission helpful: <169>How to Identify and Resolve Radio-TV Interference Problems.<170> This booklet is available from the U.S. Government Printing Office, Washington, DC 20402; Stock No. 004-000-00345-4.